

(Template for local translation, only for internal use)

Sika® Injectoflex-System Type HPM

Construction joints for watertight structures

Product Description	Swellable and injectable hose to seal construction joints in watertight structures against water and seawater.
Uses	<p>The Sika® Injectoflex-System Type HPM is used to seal construction joints in watertight structures against water and seawater. It is placed in construction joints. Penetrating water in a first phase “activates” the three exterior swelling parts attached on surfaces of the Injectoflex Hose, which start to swell. The resulting pressure forces the water to find a new and longer way through the structures and in the process seals the structure due to a reduction of water pressure.</p> <p>If necessary, in a second phase, the system can be injected, which again causes the water to attempt to travel longer distances and effectively seals the structure.</p>
Characteristics / Advantages	<ul style="list-style-type: none">■ Accurately targeted waterproofing in 2 separate phases Phase 1: Swelling by normal water- and seawater penetration Phase 2: By injection at a later stage (if necessary)■ Economical, easy to install■ Suitable for many structures and construction methods
Product Data	
Form	
Packaging	<p>The Sika® Injectoflex-System Type HPM is supplied as a complete kit in a cardboard box containing:</p> <ul style="list-style-type: none">- 40 m Injectoflex Hose Type HPM- 6 Shutter-Packers with connection pieces and connection tubes- 200 fixing hooks- 6 corner connection pieces <p>Note: Additional corner connection pieces and fixing hooks can also be ordered separately.</p>
Storage	
Storage Conditions / Shelf Life	48 months from date of production if stored in undamaged unopened and sealed original packaging, in dry conditions at temperatures between +5°C and +35°C.



Technical Data

Chemical Base	Black inner tube: EPDM	
	Red parts:	
	- Non swelling round profile: closed cell profile to keep injection discharge holes closed, while concreting works are in progress	
	Yellow parts:	
	- Swelling rectangular element: combination of hydrophilic swelling resins and rubber	
Change of Volume	Swelling parts: 7 days in salt water: $\geq 150\%$ 7 days in tap water: $\geq 300\%$	(DIN 53521)

Mechanical / Physical Properties

Shore A Hardness	Black inner tube: 80 +/- 5	(DIN 53505)
	Hydrophilic swelling parts: 75 +/- 5	(DIN 53505)
Elongation at Break	Black inner tube: $\geq 100\%$	(DIN 53504)
	Hydrophilic swelling parts: $\geq 250\%$	(DIN 53504)

System Information

System Structure

System Configuration

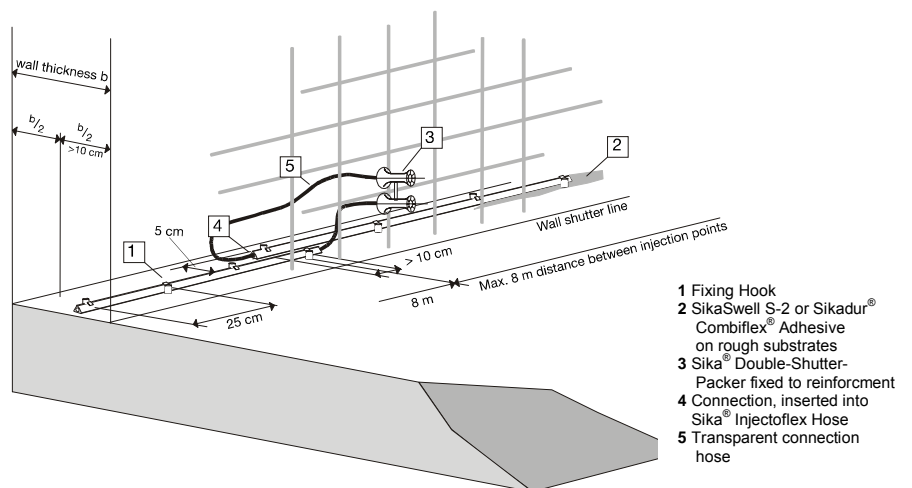

Sika® Injectoflex-Hose Type HPM

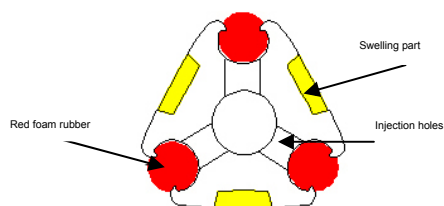

- Inner tube made from black, non swelling rubber
- 3 yellow outer, swellable areas
- 3 round red rubber profiles used to cover the injection holes

Side length ~ 23 mm

The system configuration as described must be fully complied with and may not be changed.

Sika® Injectoflex Fixing Hooks:

Yellow plastic hooks with fixing pins to fit the size of the injection hose.
Consumption: 5 hooks per 1 meter.

Sika® Injectoflex Double-Shutter-Packers:

Coloured red / green, with tie wires for easy and fast fixing to reinforcement. Each of the two pipes can be exactly aligned to the shutter line by turning them.
Transparent connecting tubes of ~ 60 cm length are fixed to the shutter-packer. Each of them is fitted with a connection piece.

SikaSwell® S-2:

One-part adhesive sealant which swells in contact with water. For rough, dry or mat damp substrates. Apply in beads to the substrate (bead-diameter depending on substrate roughness). Press injection hose into the fresh sealant. Allow SikaSwell® S-2 to harden for 2 - 3 hours before placing concrete.
Please consult the SikaSwell® S-2 product data sheet.

Sikadur®-Combiflex® CF Adhesive:

Two-part adhesive for rough, dry or mat damp substrates. Material consumption ~ 0.1 - 0.3 kg/m dependent on the substrate profile.
Please consult the Sikadur®-Combiflex® product data sheet.

Sika® Trocal Adhesive C-705:

Contact adhesive for smooth, dry substrates. Apply by brush and let dry for ~ 15 minutes. Material consumption ~ 20 g/m dependent on substrate profile and porosity.

Application Details

Substrate Quality	The substrate must be sound, clean, dry, (or “mat damp”), free from all surface contaminants.
Substrate Preparation	All loose particles, release agents, laitance, paint rust and other poorly adhering materials must be removed by suitable mechanical preparation techniques. Surface which are extremely rough can tend to leak later on. Place a narrow wooden board into the fresh concrete in order to create a groove into which the Sika® Injectoflex Hose can then be securely placed.

Application Conditions / Limitations

Substrate Temperature	Dependent on the fixing method / adhesive which has been selected. Please consult the corresponding product data sheet.
Ambient Temperature	Dependent on the fixing method / adhesive which has been selected. Please consult the corresponding product data sheet.
Substrate Moisture Content	The substrate must be dry or “mat damp”.

Application Instructions

Application Method / Tools

The Sika® Injectoflex Hose is fixed in sections of maximum 8 meters. The hose of the next section has overlap at least 10 cm. Distance between overlapping ends to be at least 50 mm (see drawing page 3). Every 8 meters a Sika® Double-Shutter-Packer is placed, which provides access for injection into the previous and the following sections (inlet and outlet are combined in the same packer-unit).

The Sika® Injectoflex Hose is always fixed on top and in the centre of the hardened concrete. The hose has to be placed in such a way that a concrete cover of at least 10 cm is possible and parallel to the surface of the inner and outer formwork.

Fixing Methods:

Smooth, flat, dry or "mat damp" surface (e.g. trowelled concrete).

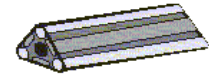

Max. 8 m

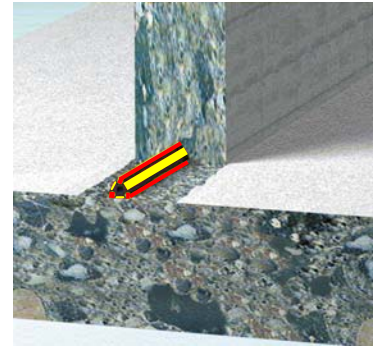

- With Sika® Injectoflex Fixing Hooks

The hooks are placed at a distance of max. 25 cm either directly into the still fresh concrete, or later hammered into holes of 10 mm diameter, drilled into the hardened concrete. The hose should be placed under the hooks just before placing of the following concrete.

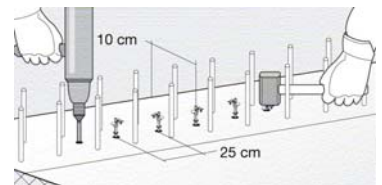
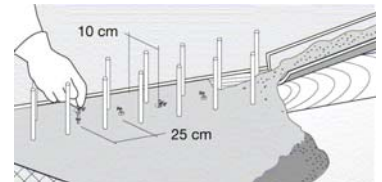

- With SikaSwell® S-2

Apply SikaSwell® S-2 in a narrow bead (size of triangular section ~ 5 mm) to the substrate. The injection hose must be placed within max. 30 minutes and pressed well into the still fresh SikaSwell® S-2 Sealant until small quantities of SikaSwell® S-2 ooze out from both sides of the hose. Secure the hose-ends at sections and at corners with fixing hooks in addition to SikaSwell® S-2. Allow SikaSwell® S-2 to harden for 2 - 3 hours before placing concrete. Please consult the product data sheet of SikaSwell® S-2.

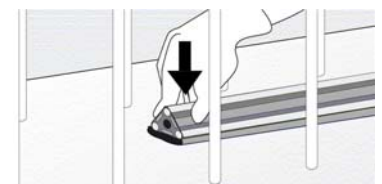
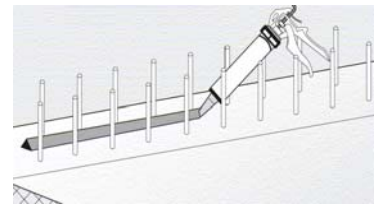

Very smooth , dry surface:

- With Sika® Trocal Adhesive C-705

The adhesive is applied the width of the hose onto the substrate as well as to the flat side of the hose with a small brush. After a drying time of ~ 15 minutes the hose is placed and pressed well onto the primed substrate.

Rough, uneven, dry or “mat damp” substrate (e.g. scabbled concrete):

- With Sikadur®-Combiflex® CF Adhesive

The thoroughly mixed adhesive is applied to the width of the hose onto the substrate. The hose is placed and pressed well into the fresh adhesive until small quantities of Sikadur®-Combiflex® CF Adhesive ooze out from both sides of the hose. Allow the adhesive to harden for a few hours before placing concrete. Please consult the product data sheet of Sikadur®-Combiflex® CF Adhesive.

Other very, smooth substrates (e.g. steel):

- Use Sika® Trocal Adhesive C-705 (see above)
- Use SikaSwell® S-2 (see above)

Corners and edges:

At corners and edges, cut the Injectoflex Hose to 45° mitre. Connect both hose sections flush with the corner connection piece. Fix the hose ends with hooks set at short distances (2 - 5 cm) or carefully bond to the substrate. In a wide radius situation the hose can be bent around the corner.

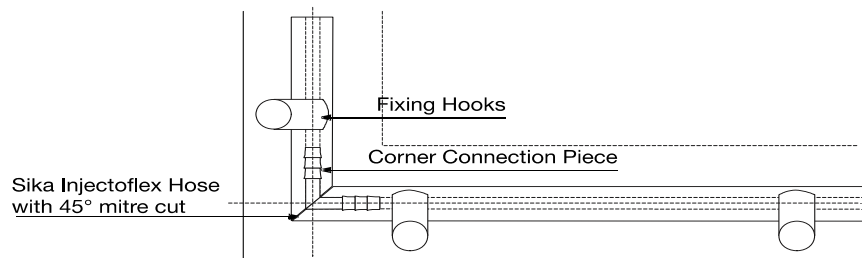
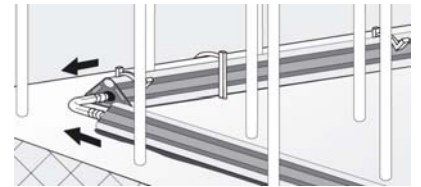

Injection Points:

At each of the 8 m overlaps, the connection to the injection-point has to be installed. This connection consists of the Sika® Double-Shutter-Packer, which has both an inlet and outlet opening complete with connecting hoses. The Double-Shutter-Packer is fixed vertically to the rebars with the tie wires so that it cannot be displaced. The level of the packers from the substrate must take into consideration the finished level (i.e. after floor screeds etc.). Vertical fixing of the packers results in better stability during concreting.

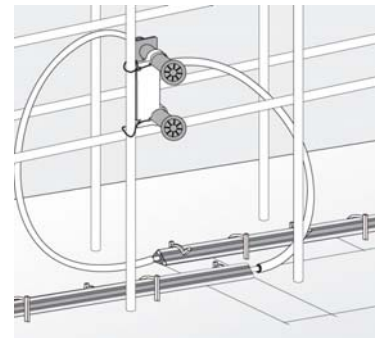

The packers can be easily adjusted to the shutter level by simply turning the two injector pipes. The cover-cones are the fixed to the shutter surface or taken through to allow for finishings.

The attached flexible connection tubes are cut to size according the actual requirement. The connection piece is inserted into the Sika® Injectoflex Hose.

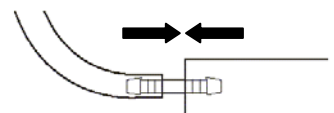

To simplify application, the packers are bi-coloured (red and green). "Green" is preferably the entry point (for the following section), and "red" the exit, or shut-off (of the previous section). Green and red parts are of identical dimensions and interchangeable if necessary.

Note: Always plan the position of the Double-Shutter-Packers in the design of the structure.

Concreting:

In order to facilitate a sound fixing of the Sika® Injectoflex Hose, the connecting tubes as well as the packers, place a layer of mortar or fine concrete at the start of the pour immediately over the hoses.

Typical mix-designs

Typical Mortar Mix	
Cement content	400 kg/m ³
Aggregate-size	0 - 4 mm (0 - 8 mm)
Additive:	
Sika® Emulsion 93	30 - 60 kg/m ³

Typical Fine Concrete Mix	
Cement content	350 kg/m ³
Aggregate size	0 - 16 mm
Admixture	As for the concrete, e.g. Sikament® (W/C ratio < 0.50)

Injection:

When water reaches the Injectoflex System Type HP M fixed with SikaSwell® S-2, water tightness is achieved by the swelling action and the resulting pressure increase. Provided the concrete is homogeneous, well compacted and without cracks. The pressure process however takes some time. If injection is carried out too soon, the process may be delayed or even prevented.

If some localised water leakage is noticed, then this may be due to:

- Insufficient substrate preparation
- Errors during concrete placement (incorrect compaction)
- Cracks
- Excessive water pressure

The leaks can be stopped in a second phase by injection through the Sika® Injectoflex System into the surrounding concrete (injection packers with external diameter of 13 mm have to be used). A further extension of the waters path is thus achieved and watertightness results.

Note: Age of concrete to be at least 4 weeks.

Injection Materials:

- Sika® InjectoCem-190
Pre-batched micro cement based.
- Sika® injection-29 New
Swellable injection resin

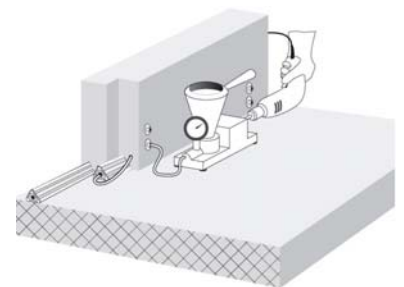

Cleaning of Tools	Clean all tools and application equipment with Sika® Colma-Cleaner immediately after use. Hardened / cured material (adhesive) can only be mechanically removed.
Notes on Application / Limitations	<p>Do not use Sika® Injectoflex-System for movement joints.</p> <ul style="list-style-type: none"> - The three external “strips” of the Injectoflex Hose swell in contact with water. This does not happen immediately, but slowly after several hours. You should not leave the Injectoflex Hose any length of time in the open air or exposed to rain water (max. 24 hours as long as water can drain away). This would deprive the Sika® Injectoflex Hose of its most important function, to swell in contact with water, once embedded in the concrete.
Value Base	All technical data stated in this Product Data Sheet are based on laboratory tests. Actual measured data may vary due to circumstances beyond our control.
Local Restrictions	Please note that as a result of specific local regulations the performance of this product may vary from country to country. Please consult the local Product Data Sheet for the exact description of the application fields.
Health and Safety Information	For information and advice on the safe handling, storage and disposal of chemical products, users shall refer to the most recent Material Safety Data Sheet containing physical, ecological, toxicological and other safety-related data.
Legal Notes	<p>The information, and, in particular, the recommendations relating to the application and end-use of Sika products, are given in good faith based on Sika's current knowledge and experience of the products when properly stored, handled and applied under normal conditions in accordance with Sika's recommendations. In practice, the differences in materials, substrates and actual site conditions are such that no warranty in respect of merchantability or of fitness for a particular purpose, nor any liability arising out of any legal relationship whatsoever, can be inferred either from this information, or from any written recommendations, or from any other advice offered. The user of the product must test the product's suitability for the intended application and purpose. Sika reserves the right to change the properties of its products. The proprietary rights of third parties must be observed. All orders are accepted subject to our current terms of sale and delivery. Users must always refer to the most recent issue of the local Product Data Sheet for the product concerned, copies of which will be supplied on request.</p> <p>It may be necessary to adapt the above disclaimer to specific local laws and regulations. Any changes to this disclaimer may only be implemented with permission of Sika® Corporate Legal in Baar.</p>



Sika Services AG
 Tüffenwies 16
 CH-8048 Zurich
 Switzerland

Phone +41 44 436 40 40
 Telefax +41 44 436 46 86
 www.sika.com

